



## SERVICE MANUAL

HOBART CHINA

EFFICIENT – RELIABLE – INNOVATIVE



## SERVICE MANUAL AMX/AM900 SERIES

Starting from Serial No 210910000



This document is produced for internal use only. The detailed settings and servicing must be carried out by service technicians qualified by HOBART. Reproduction of this document is prohibited without the written permission of HOBART.

Version 1.0 0911



As continued product improvement is a policy of HOBART, specifications are subject to change without notice.

## CONTENT

1. STANDARD MODELS – OVERVIEW .....	4
2. MACHINE DIMENSIONS .....	5
3. INSTALLATION .....	6
3.1 ELECTRICAL CONNECTION .....	6
3.2 WATER CONNECTION .....	6
3.3 DRAIN CONNECTION .....	6
4. SMARTRONIC CONTROLS .....	7
4.1 AM900 SERIES .....	7
4.2 AMX SERIES .....	8
5. FIRST RUN / CUSTOMER MENU .....	9
6. HYDRAULIC SCHEMATICS .....	10
6.1 LEGEND OF COMPONENTS .....	10
6.2 AM900 .....	11
6.3 AMX .....	12
7. FILLING .....	14
7.1 AIRGAP .....	14
7.2 PRESSURE TRANSMITTER B3 / B4 .....	15
7.3 DOSING EQUIPMENT .....	16
7.3.1 DETERGENT / RINSE AID DISPENSER .....	16
7.3.2 ADJUSTMENT OF CHEMICALS DEFICIENCY SENSORS .....	17
7.4 SOFTENER .....	18
7.4.1 GENERAL .....	18
7.4.2 SOFTENER CHECK PROCEDURE .....	19
7.4.3 SOFTENER TEST PROGRAM .....	20
7.5 BOOSTER / TANK / TEMPERATURE PROBES .....	21
8. WASHING .....	22
8.1 WASH PUMP AND STRAINER SYSTEM .....	22
8.1.1 FUNCTION (AMX only) .....	22
8.1.2 TECHNICAL DATA .....	23
8.2 RINSE PUMP .....	23
9. HOOD – DETAILS .....	24
10. HEAT RECOVERY .....	25
11. ELECTRONIC CONTROL .....	26
11.1 KEY COMBINATIONS .....	26
11.1.1 BASIC OPERATION / CUSTOMER SETTINGS .....	26
11.1.2 SERVICE MENU .....	27
11.1.3 PROGRAMMING / MODIFICATION OF BASIC DATA / SOFTENER TEST .....	28
11.2 PRINTED CIRCUIT BOARDS .....	29
11.2.1 MAIN BOARD .....	29
11.2.2 EXTENSION BOARD A3 .....	30
11.3 COUNTER FUNCTIONS .....	31
12. FAULTS .....	32
12.1 UNCRITICAL FAULTS .....	32
12.2 CRITICAL FAULTS .....	33
12.3 OTHER INDICATIONS .....	34

1. STANDARD MODELS – OVERVIEW

TYP	NO.	DEVICE NUMBER	EPROM	PROGRAM NO	COMMENT
AM900		AM900-xxxx-312	897547-010	005	
		AM900-xxxx-306/302	897547-010	005	
		AM900-xxxx-300	897547-010	009	
		AM900-xxxx-312D	897547-010	006	
		AM900-xxxx-306/302D	897547-010	006	
		AM900-xxxx-300D	897547-010	010	
		AM900-xxxx-312T	897547-010	015	
		AM900-xxxx-306/302T	897547-010	015	
		AM900-xxxx-300T	897547-010	019	
		AM900-xxxx-312DT	897547-010	016	
		AM900-xxxx-306/302DT	897547-010	016	
		AM900-xxxx-300DT	897547-010	020	
AMX		AMX-xxxx-312(H)	897547-010	001	
		AMX-xxxx-306/302(H)	897547-010	001	
		AMX-xxxx-300(H)	897547-010	007	
		AMX-xxxx-312(H)D	897547-010	003	
		AMX-xxxx-306/302(H)D	897547-010	003	
		AMX-xxxx-300(H)D	897547-010	008	
		AMX-xxxx-312(H)S	897547-010	002	
		AMX-xxxx-306/302(H)S	897547-010	002	
		AMX-xxxx-312(H)DS	897547-010	004	
		AMX-xxxx-306/302(H)DS	897547-010	004	
		AMX-xxxx-312(H)T	897547-010	011	
		AMX-xxxx-306/302(H)T	897547-010	011	
		AMX-xxxx-300(H)T	897547-010	017	
		AMX-xxxx-312/306(H)DT	897547-010	013	
		AMX-xxxx-312/306(H)DT	897547-010	013	
		AMX-xxxx-300(H)DT	897547-010	018	
		AMX-xxxx-312(H)ST	897547-010	012	
		AMX-xxxx-306/302(H)ST	897547-010	012	
		AMX-xxxx-312(H)DST	897547-010	014	
		AMX-xxxx-306/302(H)DST	897547-010	014	

Device Code Explanation

AM900 = Manual drain  
 AMX = With Genius-X<sup>2</sup>, auto drain

D = With detergent dispenser  
 H = Hood insulation  
 S = With Softener  
 T = With tubular rinse arm

## 2. MACHINE DIMENSIONS

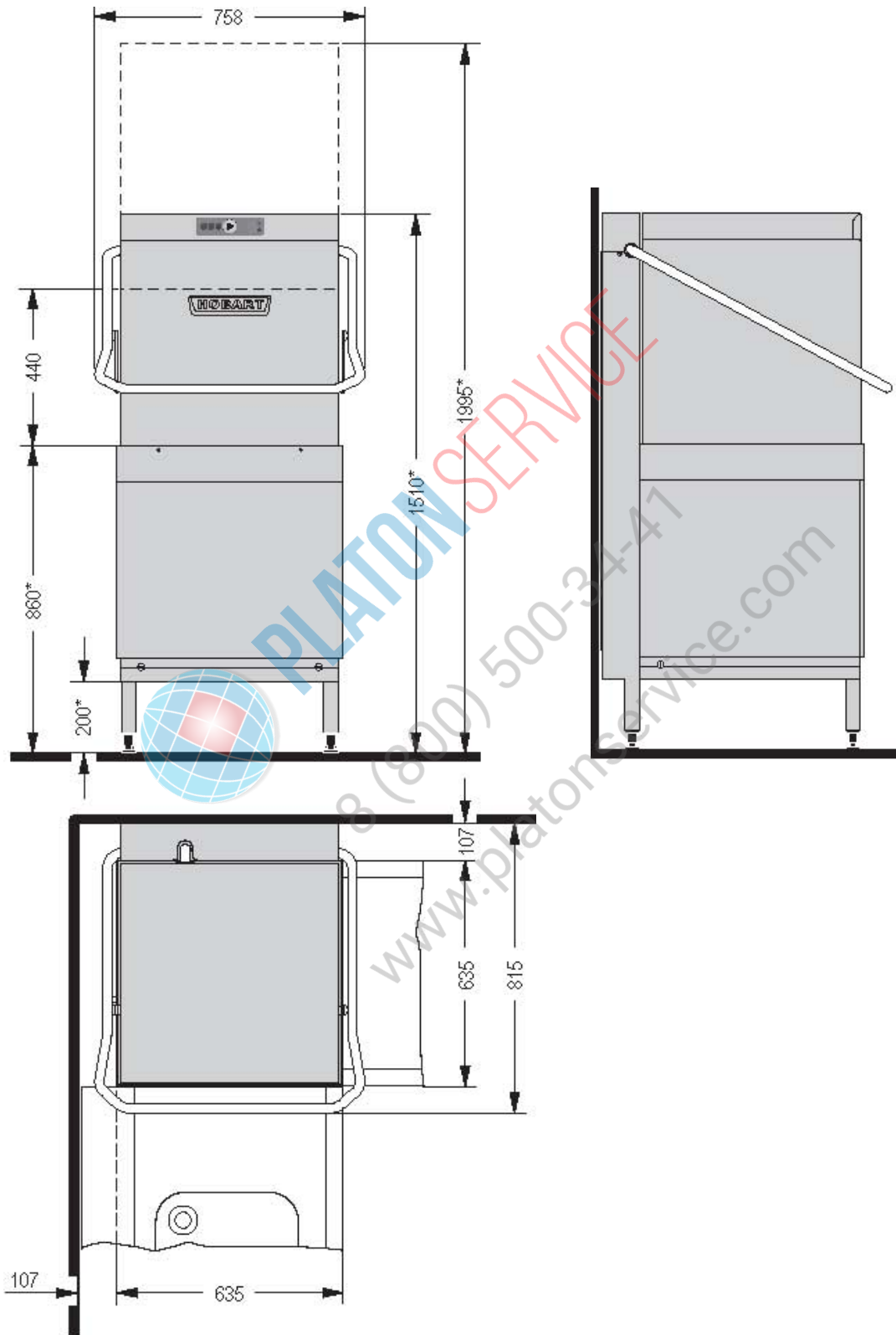

### 3. INSTALLATION

#### 3.1 ELECTRICAL CONNECTION

The machines will be supplied as standard with cable 6 (or 4) mm<sup>2</sup> (cable length approx. 2 m from cable gland). **A fused disconnects or circuit breaker with electrical leaking protector (not supplied) must be installed in the electrical line supplying the dishwasher and should meet the requirements of your local electrical code.** According to EN 60 335 the appliance must be connected to an equipotential conductor. The connecting screw (  ) is located beside the cable inlet.

#### 3.2 WATER CONNECTION

**The machines must be operated with potable water.**  
**For water with an extremely high mineral content an external demineralization is strongly recommended.**  
 Ideal conductivity value for washware made of stainless steel 80 µS/cm, for glasses 100 µS/cm and for dishes 200 to 400 µS/cm

**Machines without softener:**

The machine should be connected to soft and if possible warm water (up to 3 °dh = 0.5 mmol/l, **max. 60°C**).

**Machines with softener:**

The machine should be connected to warm water if possible (**max. 60°C**).  
 Softener has to be adjusted according to water hardness.

Line flow pressure 0.5 – 10 bar.

**Important:** the line flow pressure must not be less than 0.5 bar.

**If the line flow pressure is above 10 bars provide pressure reducer at source.**

Connect the union nut "A" (3/4") of the water supply hose to the site shut off valve. Do **not kink** or **cut** the supply hose. Eventually needed extension has to be provided with a suitable pressure hose (e.g. 324088-1).

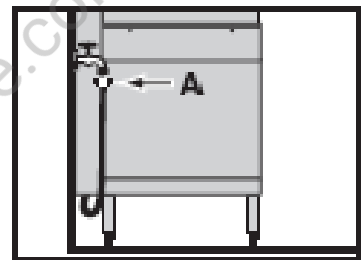

#### 3.3 DRAIN CONNECTION

**AM900 (without drain pump)**

Ensure gravity drain.  
 Drain hose must not exceed the height of **0.1 m** between floor and lower edge of the hose.  
**Otherwise it could be that water remains in tank and hose.**  
 Do **not kink** the drain hose.

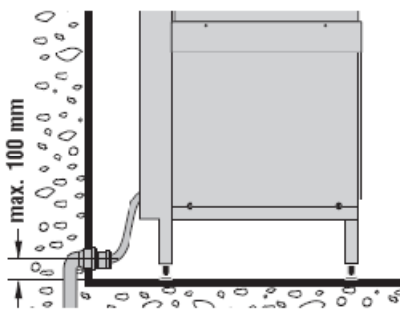

**AMX (with drain pump)**

Connection between machine and site drain must not exceed the specified height of **max. 0.75 m**.  
 Do **not kink** the drain hose.  
 Do not place the drain hose loosely on the floor (the hose could be rubbed through).  
**Fix it at site!**

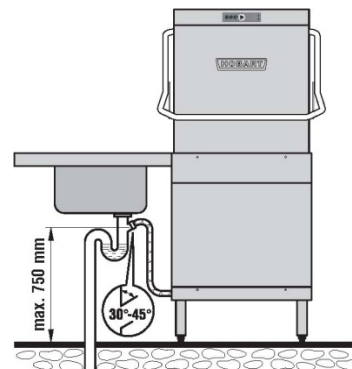

## 4. SMARTRONIC CONTROLS

### 4.1 AM900 SERIES

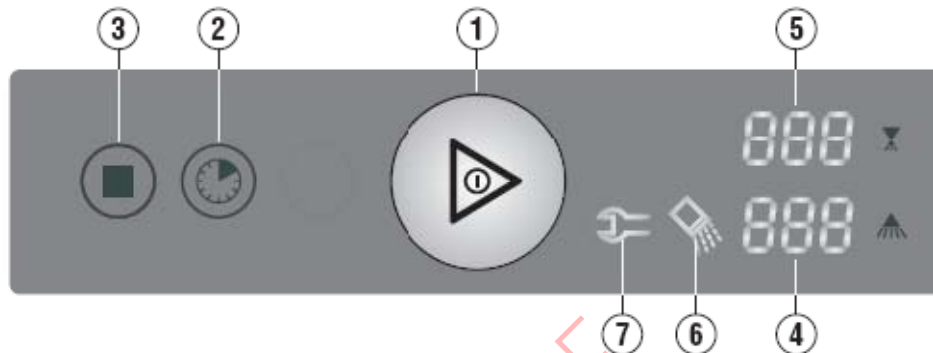

#### 1 Machine ON / OFF

Pushing this button switches the machine on.

By pushing and holding (3 seconds) this button, the self cleaning cycle starts. At the end of the cycle, the machine switches off automatically.

**After switch off, the machine is not voltage free!**

Furthermore the button illuminates to indicate the mode of the machine:

**GREEN** (flashing) = Machine is filling and heating.

Wash cycle is running.

**GREEN** (permanent) = Machine is ready for operation.

**RED** (permanent) = Critical failure (machine type setting U01)

**GREEN / RED** (alternate flashing) = noncritical failure

**BLUE/RED** (alternate flashing) = negative pressure failure

**BLUE** (flashing) = Machine is draining / switches off.



#### 2 Program button



By pushing this button it is possible to select between different preset programs, according to model and equipment. The program no. will be shown in the upper Display.

#### 3 Stop button



In case of operating error or faults, it is possible to switch-off the machine immediately without drain cycle, by pushing this button.

**After switch off, the machine is not voltage free!**

#### 4 Temperature Wash (°C)



Temperatures are only **displayed when the program button is pushed** for minimum **3 seconds**. The indicators go out **10 seconds** after releasing **program** button.

#### 5 Temperature Rinse (°C)



Permanent temperature display can be activated (set U02 S15 to "1").

#### 6 Salt required



Indicates the need for regeneration salt to be added. (Only with built-in softener.)

#### 7 Service indicator



This symbol indicates that the dishwasher has developed a fault. In the rinse temperature display appears a code (see page 33 to 35).

4.2 AMX SERIES

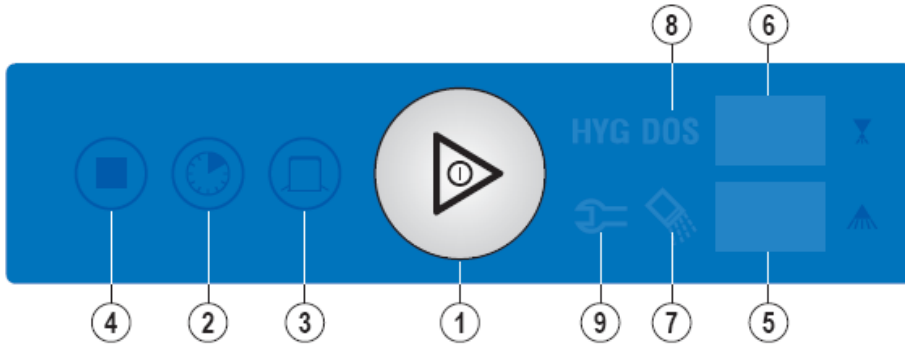

1 Machine **ON/OFF DRAIN**

Pushing this button switches the dishwasher on.  
By pushing and holding (3s) this button, the drain and self cleaning cycle starts. Once the drain cycle has completed the machine switches off automatically.  
**After switch off, the machine is not voltage free!**

The button illuminates to indicate the mode of the machine:  
**GREEN** (flashing) = machine fills and starts heating  
**GREEN** (permanent) = ready for operation (softener test U03)  
**BLUE** (permanent) = wash cycle is running (basic data U02)  
**BLUE** (flashing) = machine draining / switch-off  
**RED** (permanent) = critical failure (machine type setting U01)  
**GREEN /RED** (alternate flashing) = noncritical failure  
**BLUE/RED** (alternate flashing) = negative pressure failure



2 **Program** button



By pushing this button it is possible to select between different preset programs, according to model and equipment.  
The program no. will be shown in the upper Display.

3 **High pressure / Service** button



**AUXX (L/T) models only:** An activation of high pressure cleaning.  
Never use for cleaning glasses and light dishes (breakage)!

4 **Stop** button



In case of operating error or faults, it is possible to switch-off the machine immediately without drain cycle, by pushing this button.  
**After switch off, the machine is not voltage free!**

5 **Temperature Wash** (°C)



Temperatures are only **displayed when the program button is pushed** for minimum **3 seconds**. The indicators go out **10 seconds** after releasing **program** button.

6 **Temperature Rinse** (°C)



Permanent temperature display can be activated (set U02 S15 to "1").

7 **Salt** required



Indicates the need for regeneration salt to be added.  
(Only with built-in softener.)

8 **Detergent / Rinse aid** indicator



Indicates detergent (CH1) or rinse aid (CH2) deficiency.

9 **Service** indicator



This symbol indicates that the dishwasher has developed a fault. In the rinse temperature display appears a code (see page 33 to 35).



## 5. FIRST RUN / CUSTOMER MENU

### Initial fill of the rinse booster

On delivery, the switching function **S28** (first booster filling) is set to "0". There is no menu "boF". As the booster is controlled by a pressure transmitter, no initial fill must be carried out. Therefore the booster heating is not locked.

### Requirement: Machine "OF" and hood open

If the hood will be closed or if no button is pressed within 10 seconds, the display switches off automatically and the new settings will be saved.

**Push Stop and Program button at the same time.**

EXAMPLE: Select function with the program button.		DISPLAY		Parameter	Range
		Rinse	Wash		
1	Detergent dosage	CH1	XX	C16	0-50 s
2	Rinse aid dosage – program P01 to P04	CH2	XX	C18	0-50 s
3	Detergent dosage – not used	CH3	--	C20	0-50 s
4	Rinse aid dosage – program basic clean (AUP only)	CH4	XX	C19	0-50 s
Set chemicals values with the ON/OFF button (0.5s steps).					
5	<b>Water hardness adjustment</b> Set value with the ON/OFF button (basic setting H02). <b>H01</b> = up to 7°dh / <b>H02</b> = 8 to 14°dh / <b>H03</b> = 15 to 21°dh / <b>H04</b> = 22 to 30°dh	H01 Up to H04		C60 - C63	
To initiate a manually regeneration with the next wash cycle press the stop button for 3 seconds (confirmed by the flashing water hardness indication).		Hereby the softener function will be set to initial condition. (With next wash cycle, regeneration starts automatically.)			
6	<b>Wash cycle counter</b> Reset to "0" only via basic data (service menu).	PXX	XXX	C73 + C74	0-999999
7	<b>Water consumption counter</b> Reset to "0" only via basic data (service menu).	EXX	XXX	C77 + C78	0-999999
8	<b>Remaining water quantity counter for external water treatment</b> To reset the counter to pre-set value, press ON/OFF button for 3 seconds.	dXX	XXX	C79 + C80	0-999999
S18					
<b>CLOSE THE HOOD</b>					
9	<b>Hose priming detergent (dispenser M4)</b> By pushing the ON/OFF button, relay 5 will be activated for 60 seconds.	SF1	-- 0 -- 1		0 / 1
10	<b>Hose priming rinse aid (dispenser M3)</b> By pushing the ON/OFF button, relay 6 will be activated for: AMX(X) / AUXX = 360 seconds / AUP = 130 seconds	SF2	-- 0 -- 1		0 / 1
To interrupt a priming cycle, push the ON/OFF button again.					
11	<b>Acoustic signal (AUP models only)</b> By pushing the ON/OFF button acoustic signals will be activated ("1") or deactivated ("0"). There are 3 different signals: end of program: 1 x 2.0s "ON" noncritical failure: 2 x 0.5s with 0.5s pause critical failure: 5s continuous signal	S S	-- 0 / -- 1	S24	0 / 1
12	<b>Chemicals deficiency sensor</b> By pushing the ON/OFF button sensors will be activated ("1") or deactivated ("0").	CH	-- 0 / -- 1		0 / 1
<b>To quit the menu : – point 1 to 8 – close the hood, point 9 to 11 – open the hood            – or do not press any button during next 10 seconds            The indicator switches itself off and the new settings will be saved.</b>					

## 6. HYDRAULIC SCHEMATICS

### 6.1 LEGEND OF COMPONENTS

- B1 TEMPERATURE SENSOR BOOSTER
- B2 TEMPERATURE SENSOR TANK
- B3 PRESSURE TRANSMITTER BOOSTER
- B4 PRESSURE TRANSMITTER TANK

- E1 BOOSTER HEATING
- E2 TANK HEATING

- M1 WASH PUMP
- M2 RINSE PRESSURE PUMP
- M3 RINSE AID DISPENSER
- M4 DETERGENT DISPENSER
- M5 DRAIN PUMP

- S1 REED-SWITCH – HOOD
- S2 AIRGAP IMPELLER <sup>1)</sup>
- S3 SALT DEFICIENCY SWITCH <sup>2)</sup>
- S4 REED-SWITCH – STRAINER

- Y1 SOLENOID VALVE – FILL
- Y3.1 VALVE RESIN A <sup>2)</sup>
- Y3.2 VALVE RESIN B <sup>2)</sup>
- Y4.1 VALVE RESIN B/A <sup>2)</sup>
- Y4.2 VALVE DRAIN/BOOSTER <sup>2)</sup>

- 1 WATER SUPPLY HOSE
- 2 WATER INLET AIRGAP <sup>1)</sup>
- 3 BOOSTER
- 4 WASH ARM
- 5 RINSE ARM
- 6 SALT CHAMBER <sup>2)</sup>
- 7 RESIN A / RESIN B <sup>2)</sup>

<sup>1)</sup> AIRGAP ASSY.

<sup>2)</sup> SOFTENER ASSY.B1

6.2 AM900

WITH BOOSTER

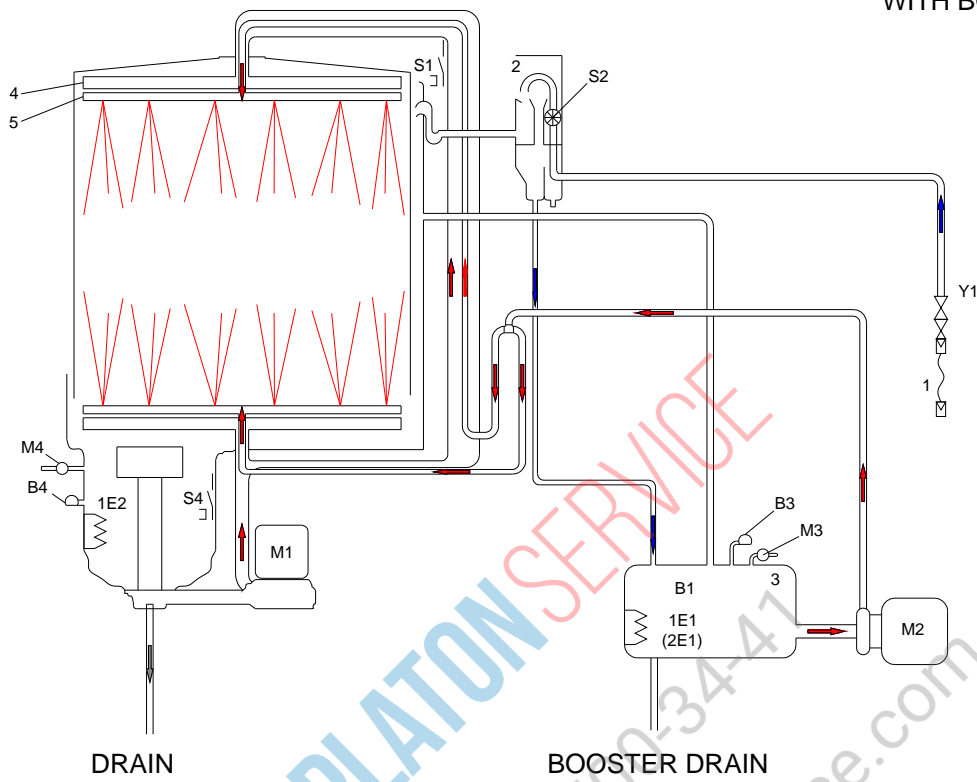

WITHOUT BOOSTER

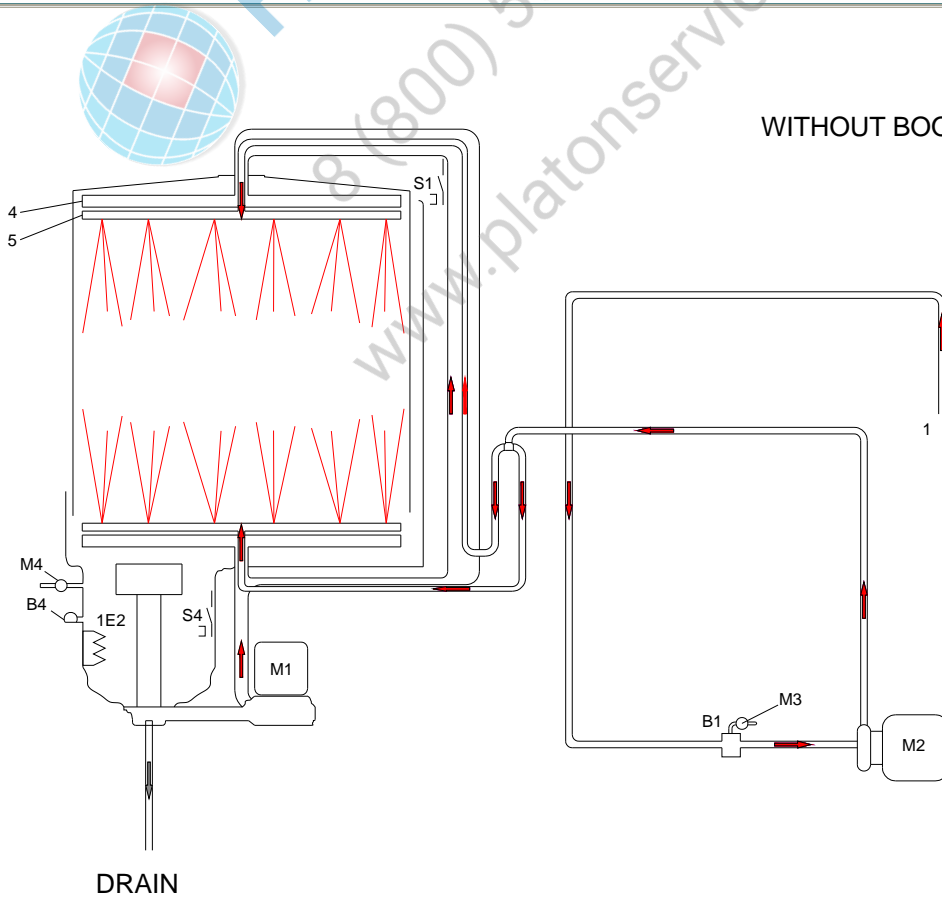

6.3 AMX

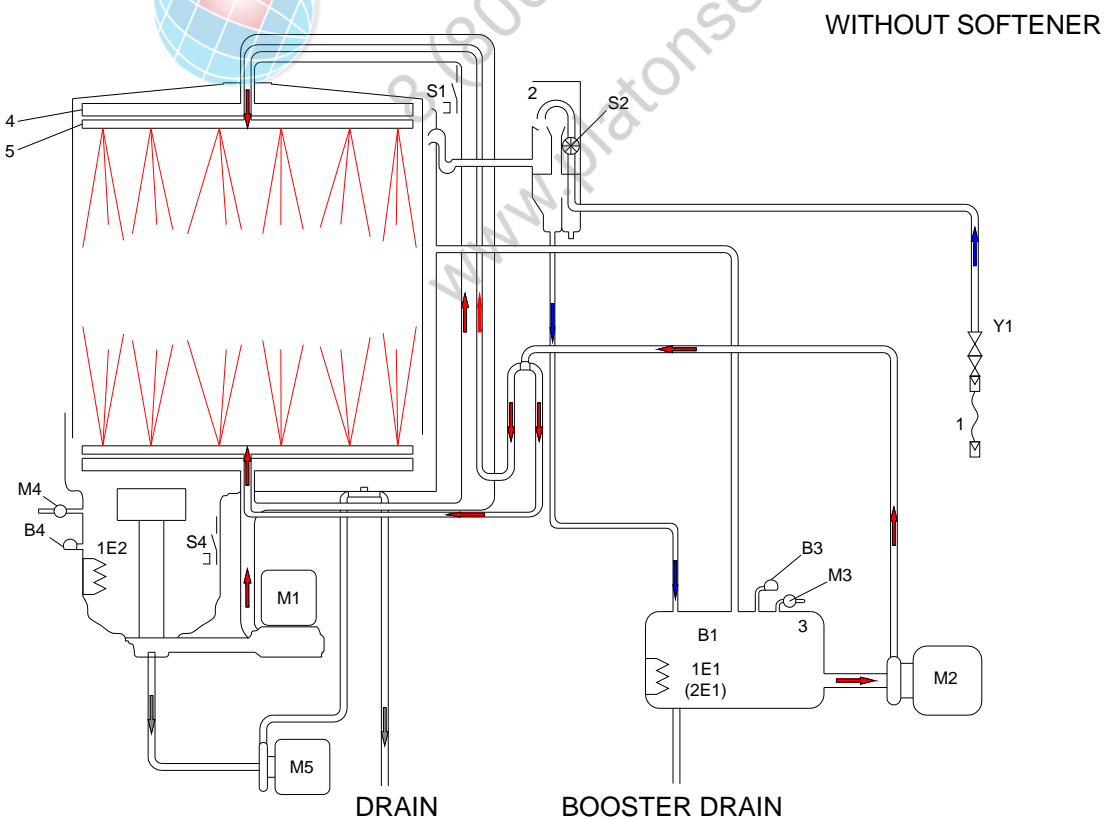
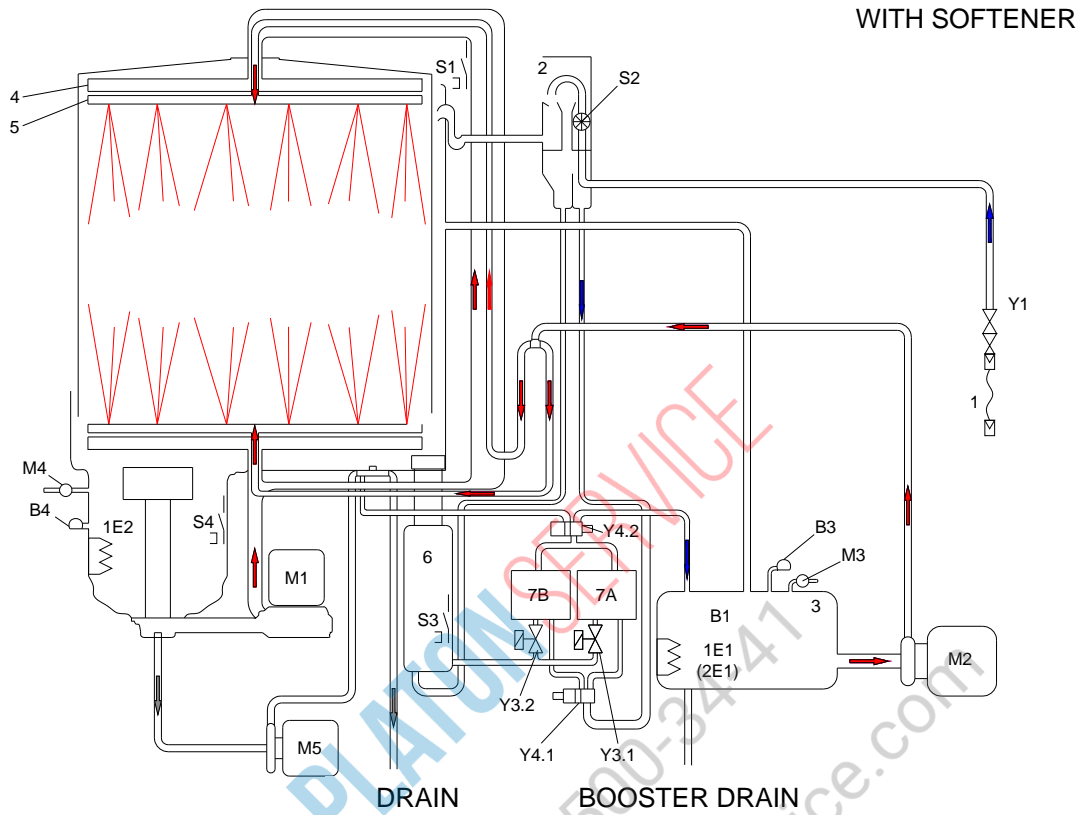

WITHOUT SOFTENER  
WITHOUT BOOSTER

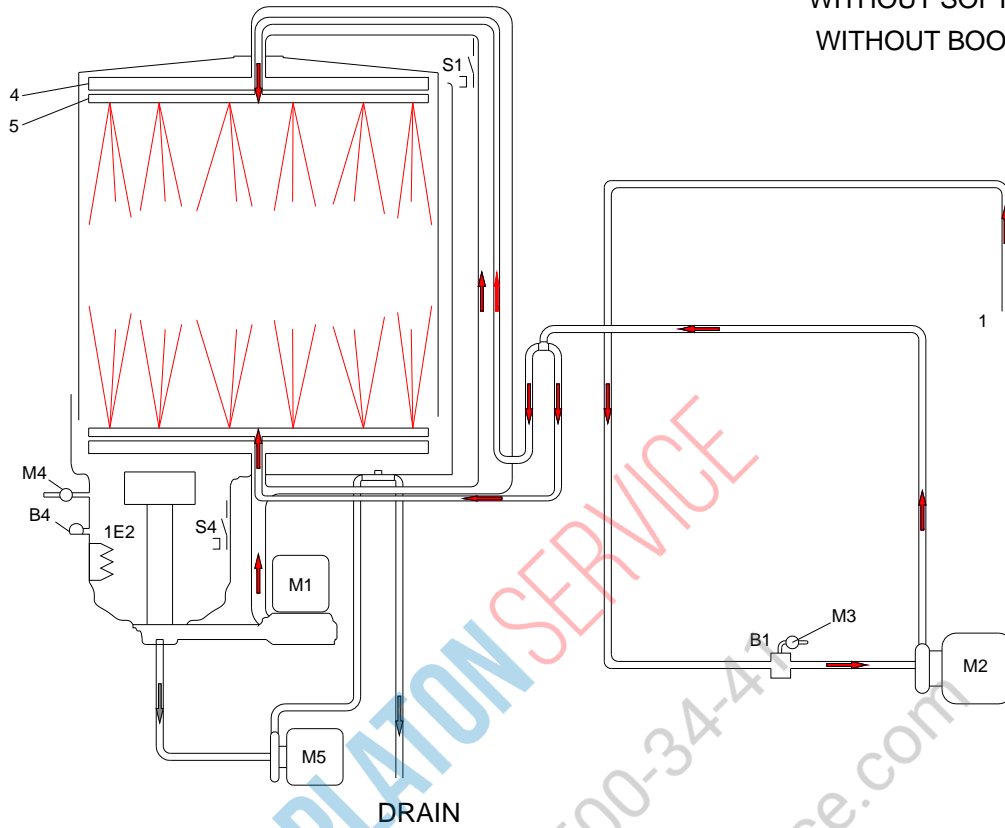

PLATON SERVICE  
8 (800) 500-34-41  
www.platonservice.com

## 7. FILLING

### 7.1 AIRGAP

The reed-switch **S2** on the small PCB 775540-1 is actuated by the impeller magnet.

The impeller monitors the incoming water flow by counting impulses and then relaying that information back to the main PCB. The count rate is **200 impulses per liter**.

1. Water consumption counter [C77] + [C78] (counted liters are added to basic value "0").
2. Remaining water quantity counter for external water treatment [C79] + [C80] + [S18] (counted liters are subtracted from preset value). See also chap. 11.3, page 32.

**MAINTENANCE – TO BE CHECKED:**

Whether leaking water from the airgap overflow (see figure1) enters the wash tank chamber (visual inspection). If so, the leaking water quantity must not exceed 100 ml per fill step.

Whether the impeller sensor works. This can be carried out in two ways.

1. Service Menu: Select input S2 and activate the fill valve by pushing the ON/OFF button (--0 / --1 will be displayed alternately). See also chap. 11.1.2, page 28.
2. Visual check: quick flashing LED on main board (see page 30).

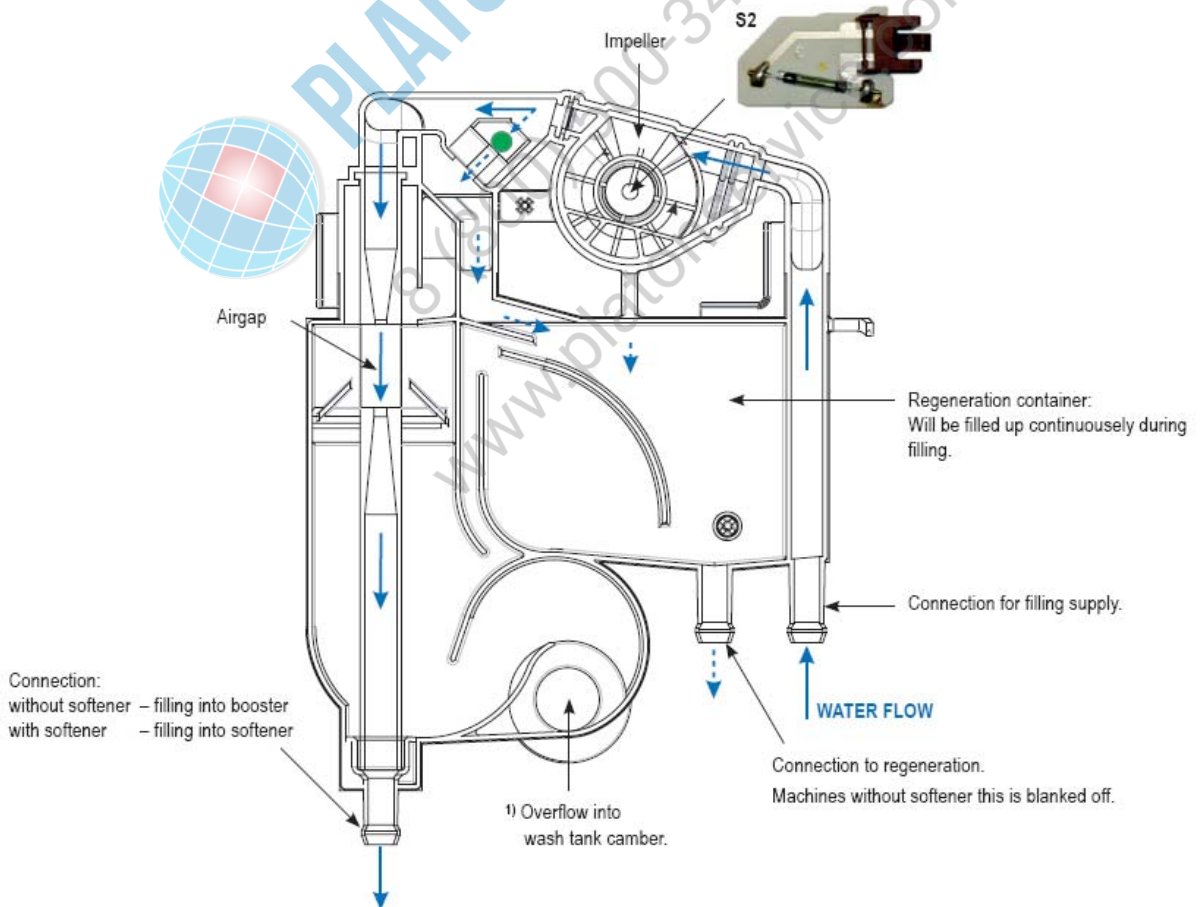

**NOTE:**

To avoid incrustations, the fill valve is activated during stand-by every 20 minutes for a short time to humidify the nozzles inside the airgap. (Parameter [S45] set to "1".)

## 7.2 PRESSURE TRANSMITTER B3 / B4

Via air traps (booster / wash tank) compressed air will be directed via clear hoses to the pressure transmitter booster (B3) and wash tank (B4). The transmitter changes the upcoming pressure into DC voltage which will be processed by the control as water level message.

If there is no fault, the voltage value can be displayed:

- via the service menu **F03** fill level booster / **F04** fill level wash tank or
- set switching function [S56] to "1" (menu U02).

Possible faults see page 34

Output voltage *	Pressure transmitter B3 (booster)
approx. 0.50 V	Booster is empty. Fill valve will be activated.
approx. 0.62 V	Booster heating will be switched on (heating up to fill start temperature <b>85°C</b> ).
approx. 0.90 V	Booster is filled. Fill valve closes.

Output voltage *	Pressure transmitter B4 (tank) – example AMX
approx. 0.50 V	Wash tank is empty.
approx. 0.65 V	Tank heating will be switched on.
approx. 1.00 V	Machine is ready for operation (tank is filled).
approx. 1.15 V	With a delay-time of 5 seconds drain pump will be activated until normal water level is reached. (Error UL)
approx. 0.60 V	At the end of the self cleaning cycle water remains in the wash tank. When the machine will be switched on the next time, "AL" error will be displayed.

### Voltage value\* additions for pressure transmitter B4 (tank):

Model	tank heating ON	tank filled	safety level (UL)	AL	Negative pressure
AMX/AM900	0.65V (ca.13 l)	1.00V (ca.21 l)	1.30V (ca. 27 l)	0.60V (ca. 12 l)	0.58V (ca. 11 l)

**\* Voltage values may not be changed by the service technician (only on instruction of HOBART).**

### MACHINES WITH EXTERNAL FILLING

If external filling is activated (S20 set to "1"), a voltage regulation of 0.1 V must take place within 30 seconds, after a holding time of 60 seconds.

Otherwise the error message FIL will be displayed.



7.3 DOSING EQUIPMENT

7.3.1 DETERGENT / RINSE AID DISPENSER

Dispensers		
<b>AMX/ AM900</b>	Detergent (775556-12): delivery rate 3.0 l/hr Rinse aid (775556-11): delivery rate 0.4 l/hr	hose inside: 775608-2 hose inside: 775608-1
Pre-adjusted values		
<b>Detergent CH1</b>	All models: "8" = 8.0 s ≈ 2.40 g/l (possible range 0-50 s ≈ 0-15.4 g/l)	
<b>Rinse aid CH2</b>	AMX/AM900: "7.0" = 7.0 s ≈ 0.31 g/l (possible range 0-50 s ≈ 0-2.2 g/l) AUP: "2.5" = 2.5 s ≈ 0.33 g/l (possible range 0-50 s ≈ 0-6.6 g/l)	
Dosage		
<b>Detergent</b>	Pre-dosing is activated simultaneous with rinse pump M2. Wash dosing is activated simultaneous with the wash pump.	
<b>Rinse aid</b>	Pre-dosing is activated after the end of the fill cycle. Wash dosing is activated after the end of wash cycle.	

Hose priming and factory settings see page 8 "Customer Menu".

Maintenance

1. Check hoses, dispensers and connections.
2. As a precaution, the dosing hoses have to be replaced every two years (hoses inside dispensers, suction and pressure hoses).

Dosing hoses (sold by meter) – part no. 01-246301-099

**Installation of dosing hoses (e.g. AMXX):**

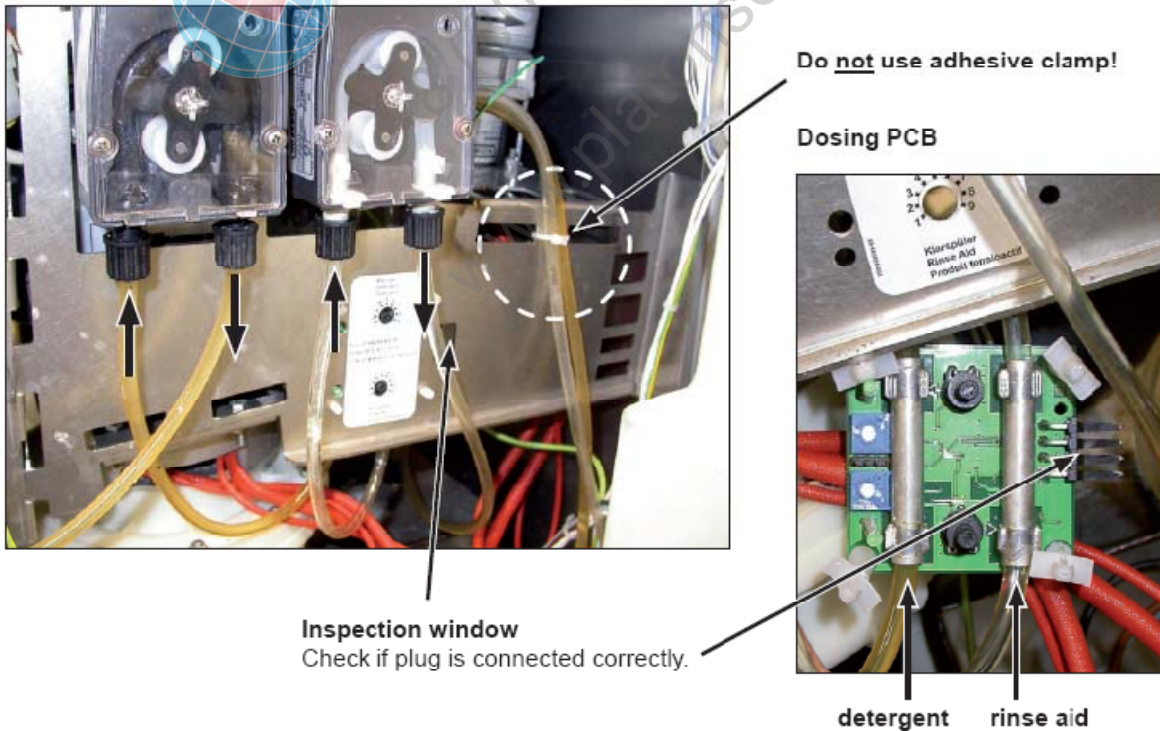



### 7.3.2 ADJUSTMENT OF CHEMICALS DEFICIENCY SENSORS

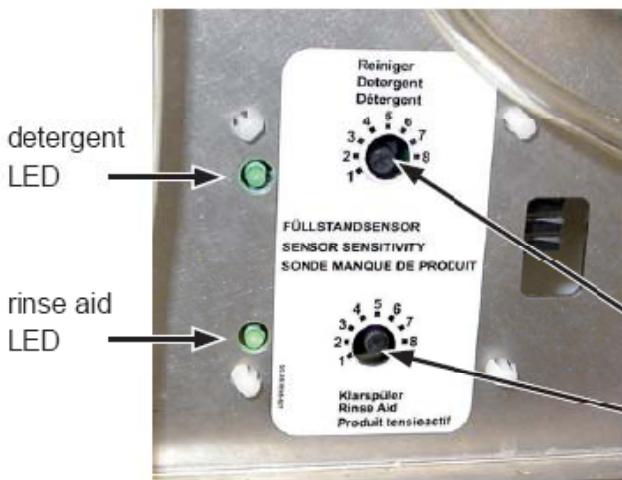

#### POTENTIOMETER:

Graduations: **1 to 9**

Sensitivity: **1** (non-sensitive chemical sensing / sensitive failure indication)  
**9** (sensitive chemical sensing / non-sensitive failure indication)

Basic setting: **3**

Detergent

Rinse aid

Due to the physical properties of rinse aid (e.g. wetting), even smallest rinse aid quantities inside the hose will be detected by the deficiency sensor. If the sensor is adjusted too sensitively, maybe deficiency will not be released.

#### – TEST "DEFICIENCY"

Flush the suction hose thoroughly with fresh water to remove any chemicals.

When the hose is drained, the respective LED should be "OF".

#### – TEST "FULL"

Fill the suction hose (see chapter 5, page 8).

The respective LED should light up. If not, adjust potentiometer until the LED lights up.

Now the hose should be completely filled and without air bubbles.

#### TESTING THE PCB

– Select **Service Mode** (see chapter 111.1.2, page 28).

– Hoses are empty and deficiency sensor potentiometers turned to **left stop**:

Switching functions "S07" (detergent) and "S08" (rinse aid) must be "0". **No** sensor LED lights up.

– Potentiometers turned to **right stop**:

Switching functions "S07" (detergent) and "S08" (rinse aid) must be "1". The LED of the respective circuit lights up.



Detergent deficiency indication "- - 0"



Rinse aid hose filled "- - 1"

– After testing:

Set potentiometers (detergent and rinse aid) to value "3" (based on tests with the most common products).

## 7.4 SOFTENER

### 7.4.1 GENERAL

Before first run, the softener has to be filled with 2 kg of regeneration salt and potable water.

**Switching function:** [S05] = "1" (standard setting for machine programs with softener)

**Salt capacity:** max. 2 kg (coarse grained, max.10 mm – no tablets)

**Salt consumption:** approx. 40 g / regeneration

**Softener setting:** see next page

**Parameters:** [C84] number of salt fillings

(see also page 33) [C85] number of wash cycles with deficiency of salt

**NOTE:**

1. Manually initiation of regeneration (salting column "B") is possible.  
See also page 8, "customer menu" point 5.
2. Y4.2 (switching Drain / Booster)  
de-energized = switched to drain / energized = filling into booster.  
It will take several wash cycles until the salt indicator switches off.

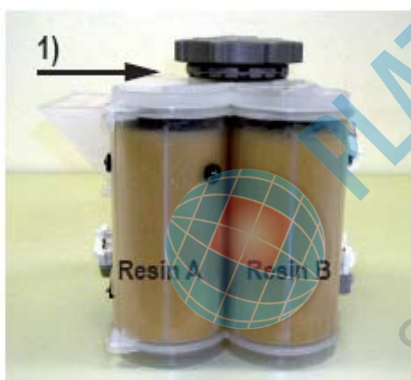

left hand view



right hand view



front view



rear view

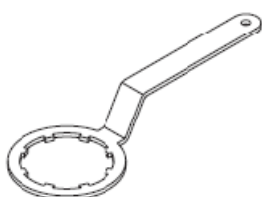

1) **Special tool needed (softener wrench 01-293500-1)**

In case of softener replacement the fastening nut has to be re-tighten after three wash cycles.

## 7.4.2 SOFTENER CHECK PROCEDURE

### Check:

Parameter [C84] = number of salt fillings.

Parameter [C85] = number of wash cycles with deficiency of salt (illuminated salt indicator).

### What you need to verify the softener function:

1. Test kit to measure the water hardness (part number 607236). Pay attention to expiry-date.
2. A conductivity-meter (possibly pH indicator strips 609927).

### How respectively where to measure?

Use clean tea-cup or beaker for sampling water.

1. Take measurement of the total water hardness (°dh) at the tap where the machine is connected to.
2. Measure the conductivity ( $\mu\text{S}/\text{cm}$ ) at the tap where the machine is connected to.
3. Measure the hardness of the water in the booster.  
Therefore, the booster drain hose is to be used. Discard the first cup of water to ensure that no residuals from the hose falsify the measured value.
4. Measure the conductivity of the booster water.

### Adjustment of softener setting according to the hardness of incoming water:

1. Ensure adequate softener setting:  
**H01** = up to 7°dh / **H02** = 8 to 14°dh / **H03** = 15 to 21°dh / **H04** = 22 to 30°dh.
2. Ensure that the salt chamber contains salt.
3. Ensure that granular salt is used (salt tablets are not allowed).
4. Ensure that the salt chamber has been filled up with water.

### Approximate values if softener function is O.K.:

The conductivity of the booster water shall be about  $300\mu\text{S}/\text{cm}$  higher than the conductivity of that water taken at the tap.

**For example:** If the total hardness of the incoming water is  $500\mu\text{S}/\text{cm}$ , the conductivity of the booster water will be roughly  $800\mu\text{S}/\text{cm}$ . If this value is significantly higher (e.g.  $3000\mu\text{S}/\text{cm}$ ), an incorrect softener function is very likely.

### Further steps:

1. Adjust the softener to "H04" to ensure a new regeneration will be actuated every 3 cycles.
2. Select the shortest program "P01" and take a sample of water (a tea-cup) at the booster drain hose immediately after the program cycle has ceased.
3. Measure and note down the water hardness.
4. Measure and note down the conductivity.

Repeat procedures 1 to 4 seven times to ensure salting of both resin columns.

An incorrect softener function is most supposable if the measured hardness at the booster drain hose is higher than 5°dh and / or the conductivity is extremely high (i. e. in the range of  $3000\mu\text{S}/\text{cm}$ ).

### Proceed as following in case of too high hardness and / or conductivity values:

1. Run the drain cycle to ensure booster emptying down to the pump intake.
2. Remove the side panels.
3. Activate the softener test program "U03" as described on next page.  
Observe the resin columns with the aid of a torch from the left hand side of the machine.  
(Column "A" is at the left, column "B" is at the right from this point of view).  
If the sequential operation deviates from the described one (see next page), i. e. resin "B" was six times activated, it is very likely that a softener valve is jamming or the electrical connections are interchanged (this is less probable).  
The booster must be flushed thoroughly at the end of this procedure (run 5 wash cycles) to ensure the chloride content is at an acceptable level to prevent corrosion.

**Never run the softener test program at the begin of the herein described procedure because it is unavoidable that salt will be flushed into the system. Thus, measurements would become incorrect.**

7.4.3 SOFTENER TEST PROGRAM

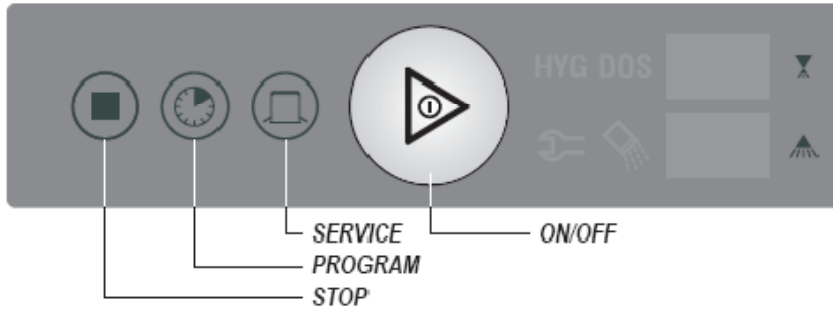

**REQUIREMENT:**

Machine has to be switched "OFF" and the hood must be open.

- Push and hold **program** and **service button (dryer button)** together.  
**U01** appears in the rinse temperature display.
- Select softener test program **U03** by pushing the **stop button**.
- To enter U03 push the **ON/OFF** button. The ON/OFF button illuminates GREEN while the test program is running. Once the test sequence has completed, the ON/OFF button will switch off.

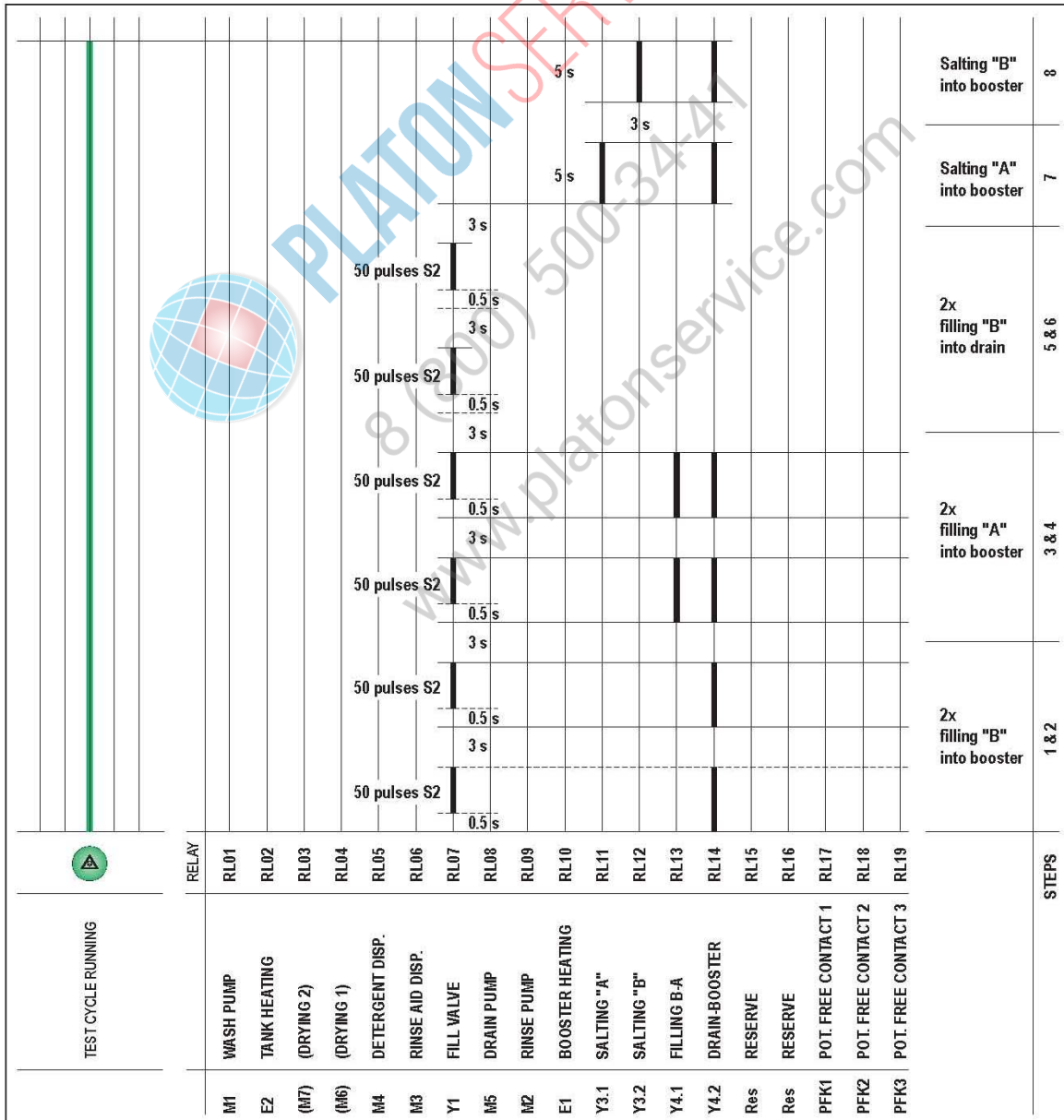

## 7.5 BOOSTER / TANK / TEMPERATURE PROBES

### BOOSTER

Booster heating:	12.6/6.3/0 kW
Total volume:	10.3 liter
Useable volume:	5.2 liter
Water consumption / rinse cycle:	2.5 liter

### Part numbers:

Booster heating <b>E1</b>	02-240135-002/00
O-ring – booster heating	01-240135-011
Air trap	01-240076-002
O-ring – air trap	01-276903-050

---

### TANK

Tank heating:	3 kW
Tank volume (liter):	21 L

### Part numbers:

Tank heating <b>E2</b>	02-883432-001
Air trap	01-240076-002
O-ring – air trap	01-276903-050

---

### TEMPERATURE PROBES

### Part numbers:

Temperature probe booster <b>B1</b>	00-775612-001
Temperature probe tank <b>B2</b>	00-775612-001

### Temperature range:

min. – 40°C  
max. + 125°C

Possible faults see page 34.

## 8. WASHING

### 8.1 WASH PUMP AND STRAINER SYSTEM

The pump unit includes motor with flange, mechanical shaft seal, impeller and capacitor.

A non return flap (called Flipper) allows the draining of the circulation system (AMX only).

The Flipper prevents soil, collected in the pump sump, from reentering the circulating system.

#### 8.1.1 FUNCTION (AMX only)

During wash cycle, the wash liquid is distributed to the upper and lower wash arm. The back flowing wash liquid is passing a strainer system, the integrated intake strainer and enters the wash pump from the outer annular space of the suction unit via the main duct.

**Drain system:** Used for partial draining of the soiled wash liquid (**Genius X<sup>2</sup>**) during wash cycle (approx. 20 seconds after program start) or for the complete draining of the wash tank. Pressure-side the soiled wash liquid will enter the drain via hose system and ventilation valve.

During draining or self-cleaning cycle the flipper is open.

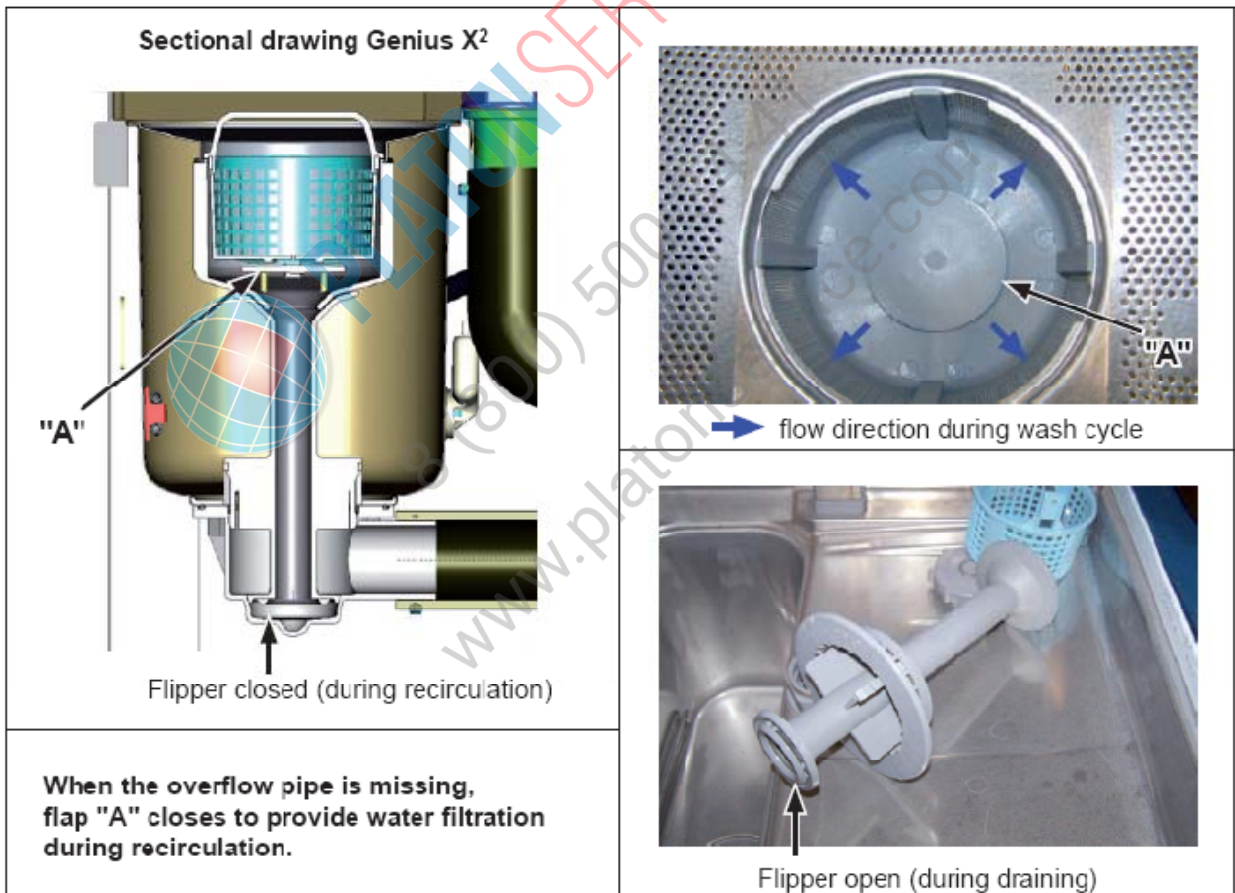

#### MAINTENANCE

- Check movability of flipper.
  - Clean fine strainer if necessary.
  - Remove drain pump and clean it.
  - Subsequently carry out leakage test.
- Furthermore the ventilation valve has to be checked for soiling.

#### NOTE:

Tank strainer and fine strainer have to be cleaned daily.

### 8.1.2 TECHNICAL DATA

#### WASH PUMPS – CONNECTED LOAD

	Part no.	Voltage / Frequency / Phases	Current	Capacitor	Power	Impeller
AMX / AM900	02-883617-1	220-240V / 50Hz / 1P	3.2A	16μF	0.73kW	104mm
AMX / AM900	02-883617-2	220-240V / 60Hz / 1P	3.4A	16μF	0.73kW	94mm

#### WASH PUMPS – SERVICE KITS

AMX / AMXT	883617-10	50Hz
	883617-20	60Hz

#### The Service Kits include:

1. O-ring
2. Impeller
3. Mechanical shaft seal

### 8.2 RINSE PUMP

Part number	7618008
Voltage	220-240 V
Frequency	50/60 Hz
Current	0.46 A
Power	0.09 kW
Capacitor	5.0 μF / 400V

rinse time	Average value	rinse time	Average value
7.5 s	2.5 l	9.5 s	3.2 l
8.0 s	2.8 l	10.0 s	3.4 l
8.5 s	2.9 l	10.5 s	3.5 l
9.0 s	3.1 l	11.0 s	3.6 l



PLATON SERVICE

8 (800) 509-3447

www.platonservice.com

## 9. HOOD – DETAILS

### MAINTENANCE

Check plastic bearings for sufficient lubrication.

#### Hood lift handle Support

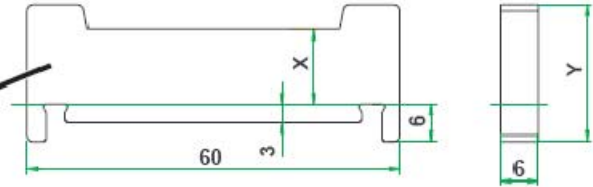
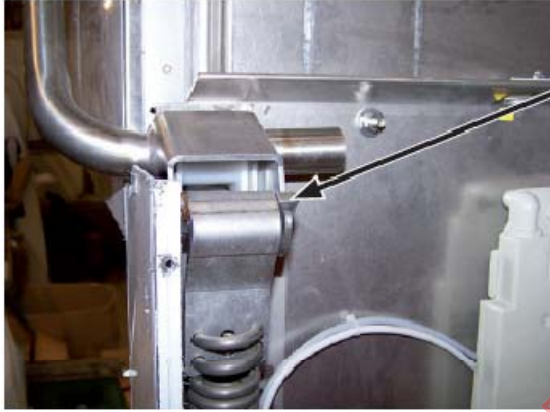

There are two different spring bolts:  
 883683-1 (x = 8 mm / y = 18 mm)  
 883683-2 (x = 12 mm / y = 22 mm)

See also table below.

#### Adjustment of tension springs

Example: AMX

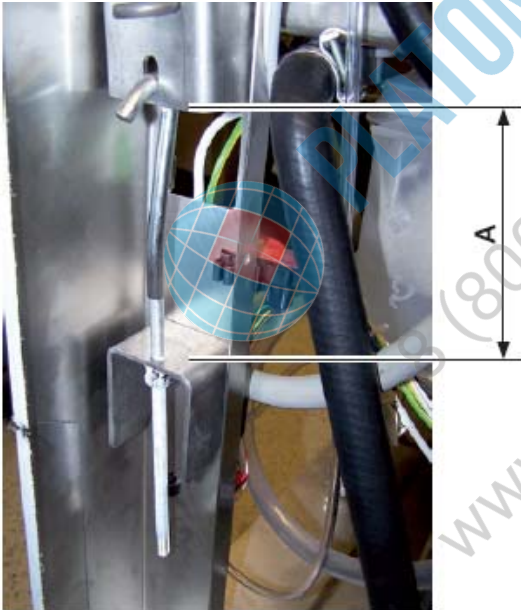

Distance "A" from lower edge of bent to upper edge of channel:

approx. 12 cm – **insulated hood**

approx. 18.5 cm – **non-insulated hood**

#### Insufficient spring force:

The hood keeps not safe in "stand-by" position or closes.

#### Too much spring force:

The hood does not keep tightly closed during wash cycle.

**Make sure, that in "stand-by" position the hood neither opens nor slowly closes.**



## 10. HEAT RECOVERY

### GENERAL

With activation of the fill valve (booster refill), the control 897545-1 will be actuated by an impulse and starts the drain pump (partial tank draining, approx. 2.5 l) simultaneous to filling. The output clock signal is adjustable via basic data.

The fresh water enters via the airgap the outer coaxial pipe of the heat exchanger and will be heated up by tank water, flowing in the inner coaxial pipe (counter-flow principle).

Menu U02 – Basic Data:

Switching function [S32] is set to "1".

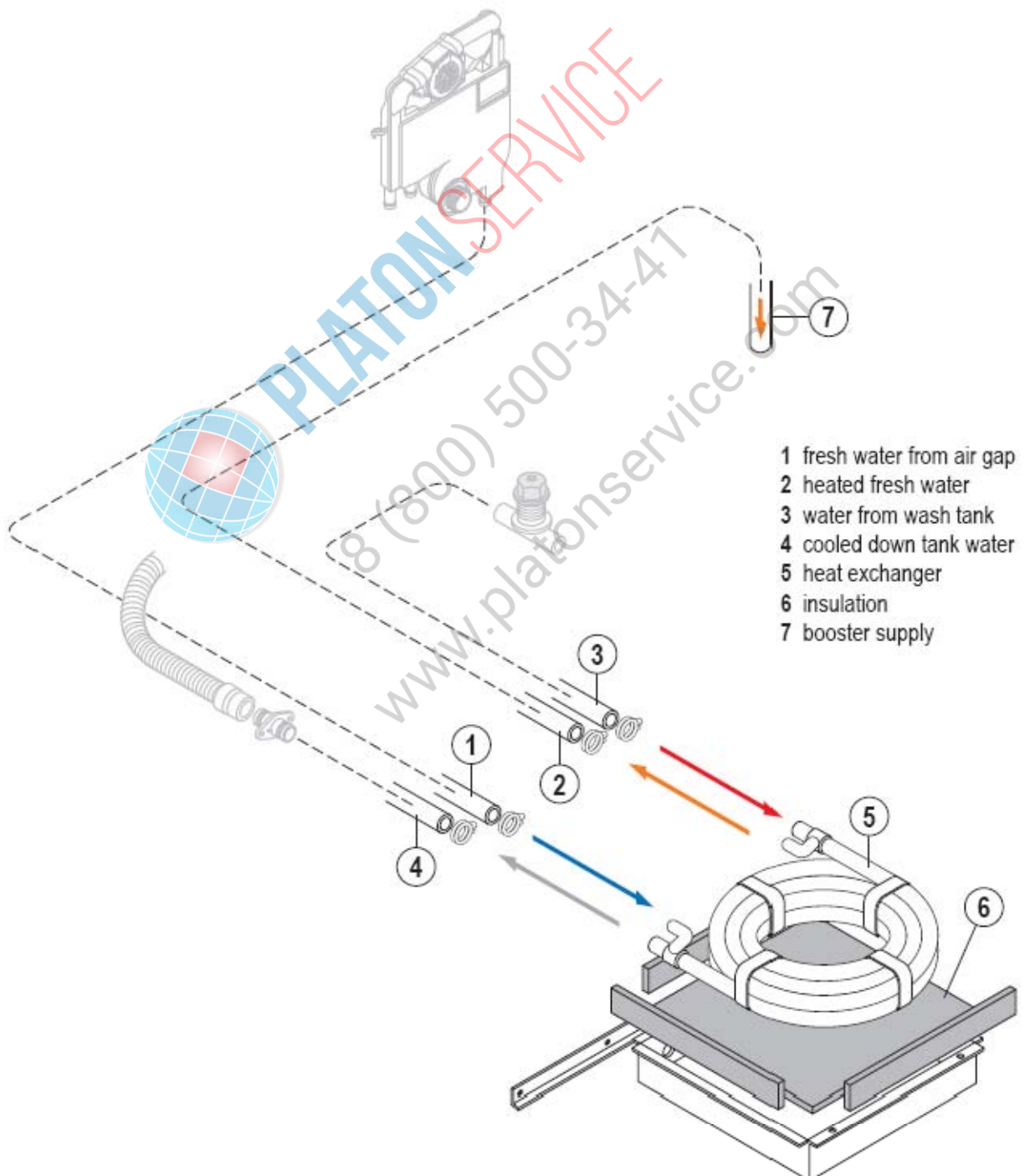

## 11. ELECTRONIC CONTROL

### 11.1 KEY COMBINATIONS

#### 11.1.1 BASIC OPERATION / CUSTOMER SETTINGS

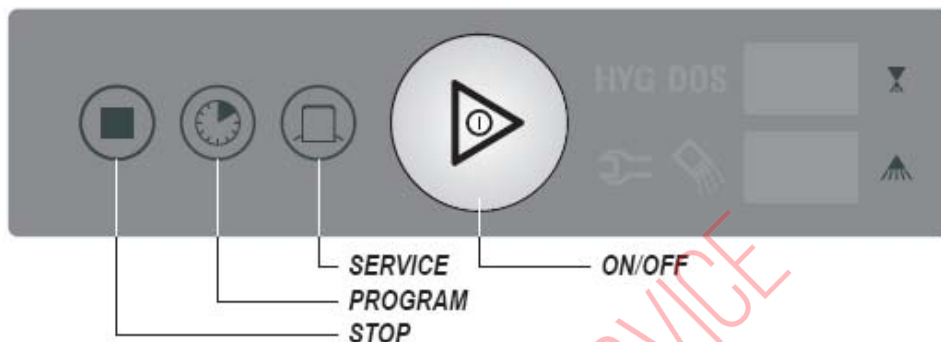

X = button to be pushed

BASIC OPERATION	STOP	PROGR.	SERVICE	ON/OFF	REQUIREMENTS	HOOD
Machine ON				X	Machine "off"	Open or Close
Machine OFF	X				Machine "off" at any time	Open or Close
Drain program				X >3 s	Start at any time	Close
Program selection		X			Machine on / Fill program completed	Open or Close
Program start				X	Machine on / Fill program completed	Close
Temperature display		X >3 s			Temperature display for 10 seconds	Open or Close
Special programs			X		Machine on / Fill program completed	Open or Close

CUSTOMER SETTINGS	X	X			MACHINE OFF	OPEN
	DISPLAY					
	UPPER	LOWER				
Detergent dosage	CH1	value C16	Select function with the program button. Set value with the ON/OFF button.			Open
Rinse aid dosage	CH2	value C18				Open
Detergent dosage Cold 1	CH3	value C19				Open
Detergent dosage Cold 2	CH4	value C20				Open
Hardness	H01 - H04					Open
Wash cycle counter	P + C74	value C73	Reset only by Service.			Open
Water counter - Total	E + C78	value C7				Open
Water counter - Demi	d + C80	value C79		Reset by pushing the ON/OFF button for 3 seconds.		
<b>CLOSE HOOD</b>						
Hose priming detergent	SF1	0 - 1	Select function with the program button.			Close
Hose priming rinse aid	SF2	0 - 1	Activate appropriate dosing pump with the ON/OFF button.			Close
Acoustic signal	S	0 - 1	Activate / deactivate with the ON/OFF button.			Close
Chemicals sensor	CH	0 - 1	Activate / deactivate with the ON/OFF button.			Close

See also page 10 "First run / Customer Menu" and page 32 "Counter Functions".

### 11.1.2 SERVICE MENU

**Requirements: Machine OFF and Hood open.**

Push **Stop**, **Program** and **Service** button to enter the Service Menu.

		DISPLAY:	UPPER	LOWER	
			S01	-- 0	(ON/OFF button illuminates)
<b>CLOSE HOOD (door switch test S1)</b>			S02	-- 1	
<b>Select appropriate Input or Output by pushing the Program button.</b>					
<b>Inputs test:</b>					
X13.3	Impeller switch Push ON/OFF to activate additionally fill valve Y1.		S02	-- 0	no signal / -- 1 signal from S2 / -- 1 will be displayed alternately
X13.5	Salt switch status		S03	-- 0	salt container is filled / -- 1 when
X13.7	Strainer		S04	-- 0	not in place / -- 1 strainer in pla
X13.9	Reserve		S05	-- 0	
X13.11	Reserve		S06	-- 0	
X12.3	Detergent deficiency1)		S07	-- 0	no deficiency / -- 1 when empty
X12.4	Rinse aid deficiency1) 1) Push ON/OFF to activate the respective dispenser Activation will persist until remedy of deficiency.		S08	-- 0	no deficiency / -- 1 when empty moving light point – dispenser
<b>Temperature probes test:</b> 0-105°C = okay / -- 1 = short circuit (>99°C) / -- 2 = open circuit (< 0°C)					
X14.1/2	Temperature sensor B1		F01		actual Temperature
X14.3/4	Temperature sensor tank B2		F02		actual Temperature
<b>Pressure transmitter test:</b> 0.3 - 4.0V = okay / -- 1 = > 4.0V / -- 2 = open circuit < 0.3V					
X14.7	Pressure transmitter B3		F03		voltage display (booster level)
X14.10	Pressure transmitter tank B4		F04		voltage display (tank level)
<b>Outputs</b> -- 0 = not active / -- 1 = active					
<b>Hood must be closed.</b> Selected output can be activated with the ON/OFF button. <b>Starting from A01:</b> push Stop button to scroll back.					
	Voltage supply Triac	RL1.1	A00	-- 0	
X1.1/3	Bypass Triac	RL1	A01	-- 0	
X2.1/2	Tank heating E2 (K2)	RL2	A02	-- 0	
X3.1/3	Wash pump High	RL3	A03	-- 0	AUXX / AUP
	Wash pump Low			-- 0	AMXT / AUXT
X4.1/3	External fill Y2	RL4	A04	-- 0	(option)
X5.1/3	Detergent dosage M4	RL5	A05	-- 0	
X6.1/3	Rinse aid dosage M3	RL6	A06	-- 0	
X7.1/3	Fill valve Y1	RL7+ RL14	A07	-- 0	
X8.1/3	Drain pump M5	RL8	A08	-- 0	
X9.1/3	Rinse pump M2	RL9	A09	-- 0	
X10.1/3	Booster heating E1	RL10	A10	-- 0	
X21.6	Softener - salting A Y3.1	RL11	A11	-- 0	only with built
X21.7	Softener - salting B Y3.2	RL12	A12	-- 0	only with built
X21.8	Fill B-A Y4.1	RL13	A13	-- 0	only with built
X21.9	Drain / booster Y4.2	RL14	A14	-- 0	only with built
X22.1/3	Reserve	RL15	A15	-- 0	only with built
X23.1/3	Reserve	RL16	A16	-- 0	only with built
X24.1/2	PFK1	RL17	A17	-- 0	only with built
X25.1/2	PFK2	RL18	A18	-- 0	only with built
X26.1/2	PFK3/	RL19	A19	-- 0	only with built
	Wash pump High				AUXXT
X1.1/3	Wash pump	RL1+RL1.1	A20		AMX / AMXX / AUXX / AUP AMXT / AUXXT
	Wash pump Low				
	Handle lightning		G r l	- FF	
	Operation unit test		BAE	-- 0	
	Counter reset (C72-C80)		r ES	-- 0	/ - 1 when ON/OFF button is

**EXIT the test program by opening the hood (only possible with menu item "outputs test").**

11.1.3 PROGRAMMING / MODIFICATION OF BASIC DATA / SOFTENER TEST

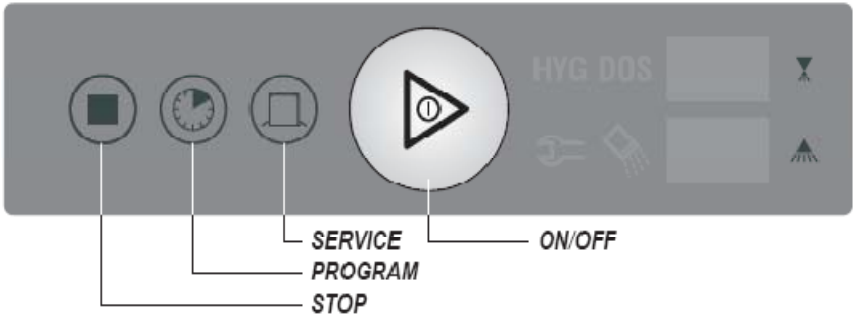

**Requirement: machine "OFF" and hood open.**

- Push **Program** and **Service** button together.  
Software release will be displayed short-time.
- Push **Stop** button to select the menu item.
  - U01** = Machine type selection
  - U02** = Basic data sheet
  - U03** = Softener test program
- The selected function will be confirmed with the **ON/OFF** button and indicated by the illuminated ON/OFF button.
  - Red** = Machine type selection
  - Blue** = Basic data sheet
  - Green** = Softener test program

---

**MACHINE TYPE SETTING: U01**

- Set machine type with the **Stop** button (01 – 20, sequential scan only).  
Program Number see page 4.
-  Push **ON/OFF** button for 2 seconds.  
The selected program with the basic data's will be saved and the "Red" illuminated **ON/OFF** button switches off.

---

**MODIFICATION OF BASIC DATA: U02**

- Set function with the **Stop** button (forwards) or first **Program** button and then **Stop** button (backwards).  
(Sequential scan or quick scan by holding the button.)
- Change value upwards (+) with the **Program** button and downwards (-) with the **Service** button.  
(Sequential scan or quick scan by holding the button.)
- Decimal points will appear.
-  Push and hold the **ON/OFF** button.  
New value is saved when the points disappear.

---

**SOFTENER TEST PROGRAM: U03**

-  Push **ON/OFF** button.  
Test program starts according to diagram (see page 21).

## 11.2 PRINTED CIRCUIT BOARDS

### 11.2.1 MAIN BOARD

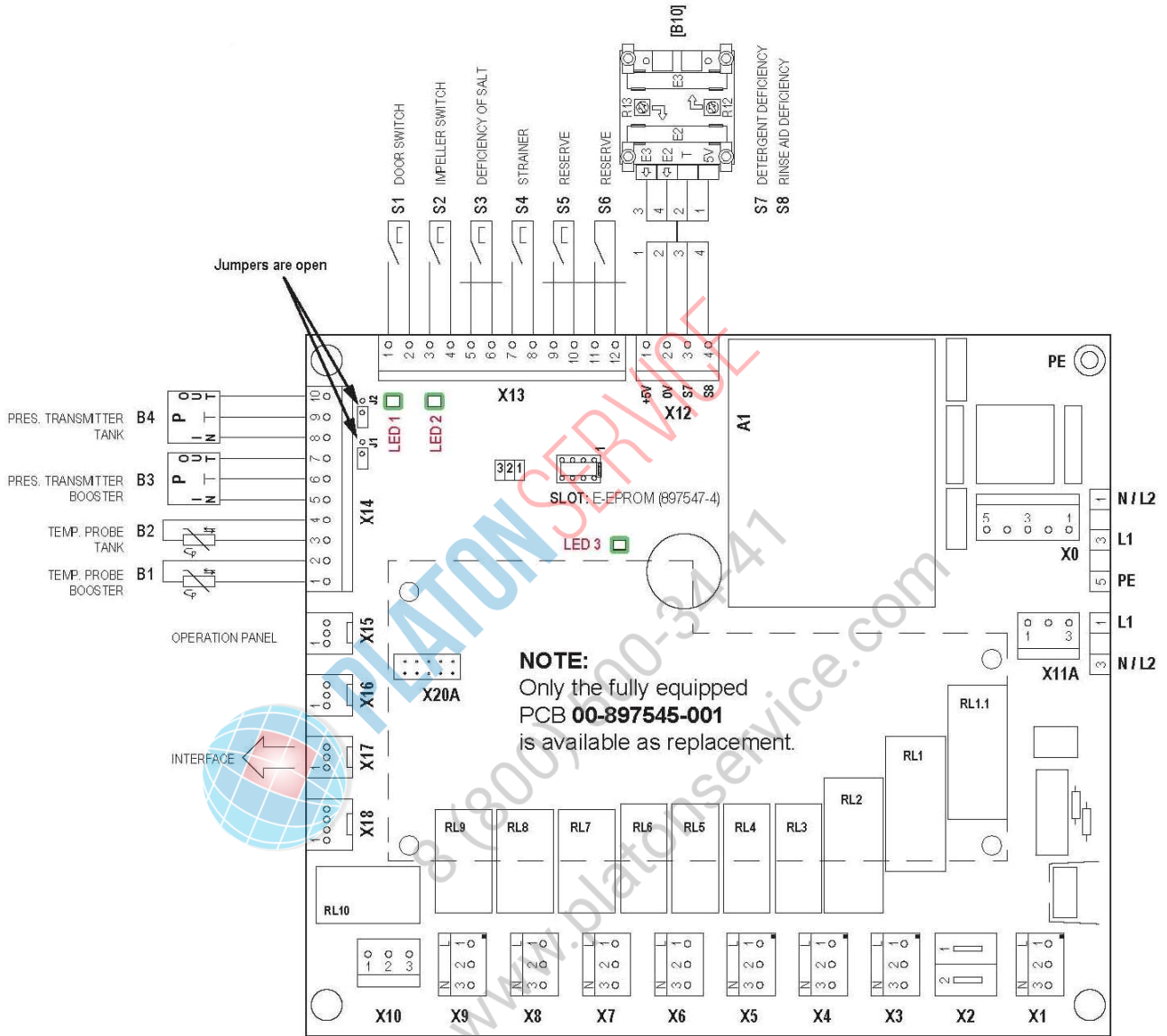

- LED 1** hood switch:                      *ON = hood closed*
- LED 2** impeller switch:                *unsteady = water flow (pulses)*
- LED 3** processor function:              *flashing = voltage on, processor running*  
    *permanent = voltage on, processor not running*

**Note:** The control works with or without plugged E-EPROM **897547-010**.

**TO INSTALL A NEW SOFTWARE RELEASE:**

- 1. Disconnect control fuse F1.**
2. Plug in the new E-EPROM and reconnect F1.  
A check is carried out and the stored software will be updated automatically (The progress is indicated at the display by L9, L8, ...).
3. Set machine type – see page 30, menu **U01** (also to be done after replacing the PCB).
4. Disconnect control fuse F1, remove E-EPROM and reconnect F1.

11.2.2 EXTENSION BOARD A3

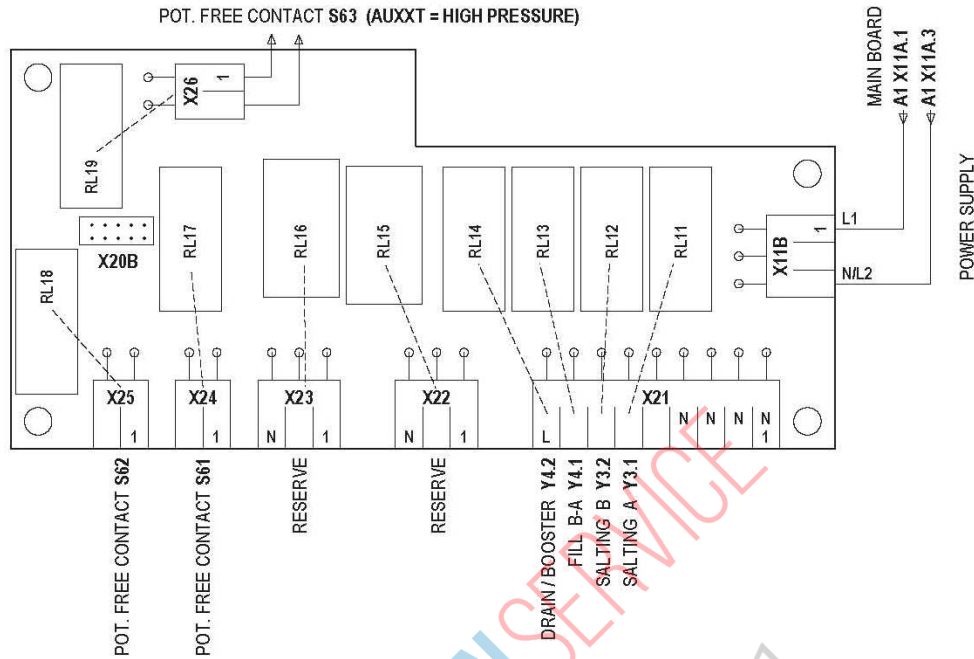

NOTE:

The additional board (897546-1) is only built in at machines with softener.

This PCB has three potential-free contacts. Each one can be assigned to different switching functions via one parameter (only on extension board):

Parameter [S61] =	RL17 (X24) switches:	PFK1
0 =	machine "On"	
1 =	program "On"	
2 =	temperature F02 / F05 below pre-set value	
3 =	fill or wash program active	

Parameter [S62] =	RL18 (X24) switches:	PFK2
0 =	program "On"	
1 =	machine "On"	
2 =	rinse pump "On" (switch-off delay [C86])	
3 =	fill program active	

Parameter [S61] =	RL17 (X24) switches:	PFK3
0 =	fill program active	
1 =	rinse pump "On" (switch-off delay [C86])	
2 =	temperature F02 / F05 below pre-set value	
3 =	fill or wash program active	

### 11.3 COUNTER FUNCTIONS

**Request for hygiene program [C71] – down-counter**

The number of wash cycles will be subtracted from the preset value ([S19] "on").

When "0" is reached, start of hygiene program is requested.

After hygiene cleaning is completed, this counter will be reset to basic value.

**Number of hygiene cycles [C72] – up-counter / basic value "0"**

The number of completed hygiene cycles is counted.

Reset only possible via basic data.

**Note:** Control, how often the program has been started.

**Number of wash cycles [C73] + [C74] – up-counter / basic value "0"**

The number of wash cycles will be counted.

Example **1420** cycles: [C73] = **420** / [C74] = **1**

**Note:** Readout and note down in the report.

**Service interval [C75] + [C76] – down-counter**

The number of wash cycles will be subtracted from the preset value ([S17] "on").

When [C75] + [C76] are "0", the service indicator illuminates.

Reset only possible via basic data.

**Note:** Of interest in case of service contract.

**Water consumption [C77] + [C78] – up-counter / basic value "0"**

After **200 input pulses** of S2 (= 1 liter water flow), the counter value will be increased by 1.

Input pulses **below 200** are buffered and counting will continue with the next input pulses.

Reset only possible via basic data.

**Note:** The customer can readout the actual water consumption (see page 8 "customer menu").

**Remaining water quantity (external water treatment) [C79] + [C80] + [S18] – down-counter**

This function will be programmed via service mode **U02** (see page 28).

[S18] = activation

[C79] + [C80] = water treatment capacity (liter). Possible settings are [C79] **0-999**, [C80] **0-999 x 1000**.

Example **5500** liters: [C79] = **500** / [C80] = **5**

After **200 input pulses** of S2 (= 1 liter water flow), the counter value will be decreased by 1.

Input pulses **below 200** are buffered and counting will continue with the next input pulses.

When "0" is reached, "d 0" will be displayed.

Reset to pre-set value via customer menu by pushing the ON/OFF button (see page 8).

**Note:** The actual value can be checked via customer menu (indication for next replacement of external demineralization cartridge for example).

**Numbers of salt fillings – deficiency of salt [C84] – up-counter**

The number of "salt indicator switch-on" will be counted.

**Note:** With this parameter you can check how often the softener has been refilled.

**Wash cycles with deficiency of salt [C85] – up-counter**

The number of started wash cycles in spite of salt deficiency (illuminated salt indicator) will be counted.

**Note:** Maybe an evidence in the case of calcified machine or heating elements for example.

**NOTE:**

**Starting from E-EPROM rev. 3.0, the actual counter readings keep unchanged after software update as well as settings of detergent and rinse aid dispensers (rev. 3.9).**



**Reset of all counters can be carried out via menu option RES in Service Menu.**

## 12. FAULTS

### 12.1 UNCRITICAL FAULTS

Fill, wash and drain program can be started.

During the fill program, uncritical faults are only indicated by the indicator lights and error codes (none green/red flashing ON/OFF button).



INDICATOR			The ON/OFF button is flashing GREEN/RED alternately.		PROGRAM
Rinse	Wash	Lamp	FAULT		PROGRAM
AL			<b>Drain fault</b>	Level switch value [F11] still exceeded at the end of the drain cycle. To reset, repeat drain program until value is below [F11].	F11
			<b>Possible cause</b>	<b>Remedy</b>	
			1. Kinked drain hose.	1. Place drain hose correctly.	
			2. Drain pump does not run (jammed or defective).	2. Check drain pump, dismantle if necessary.	
			3. Pressure transmitter B4 defective (wiring, PCB).	3. Check voltage level (service menu).	
			4. Trap possibly clogged.	4. Check trap.	
HEI			<b>Thermostop</b>	The thermostop time [C25] is exceeded (max. heating period for wash and fill cycle). Reset via machine "OF-ON".	C25 S02 S58
			<b>Possible cause</b>	<b>Remedy</b>	
			1. Booster heating defective.	1. Replace booster heating.	
			2. Missing phases.	2. Check phases (also at site).	
			3. Machine single-phase connected (230 V).	3. Connect to three-phase current if possible.	
			4. Tank heating defective (with thermostop tank) parameter S58	4. Replace tank heating	
CH1 CH2		DOS	<b>Chemical deficiency</b>	Detergent deficiency X12.3 "on" / rinse aid deficiency X12.4 "on". If both containers are empty, CH1/CH2 is displayed alternately.	S06
			<b>Possible cause</b>	<b>Remedy</b>	
			1. Chemical container empty / suction hoses not filled.	1. Refill container / carry out hose priming.	
			2. Adjustment of chemical deficiency sensors not correct.	2. Check settings (see chap. 7.3.2, page 17).	
			3. Missing electrical supply (X12.1/2).	3. Check voltage (X12.1 +5V, X12.2 0V) / check crimp connection.	
SAL			<b>Salt deficiency</b>	Softener salt deficiency indication – X13.5 "on" (only if softener [S05] = "1").	S05
			<b>Possible cause</b>	<b>Remedy</b>	
			1. Salt container empty.	1. Refill container with regeneration salt.	
			2. Float switch inside salt container jammed [S3].	2. Loose the container a little and shake slightly.	
			3. Loose contact on PCB (X13.5/6).	3. Check crimp connection and contacts.	
d 0			<b>External water treatment (option)</b>	Only if activated in service mode [S18]. The preset water quantity [C79] + [C80] is reached (down-counter). For reset see customer menu.	S05
			<b>Possible cause</b>	<b>Remedy</b>	
			1. Counter reading of preset water quantity (liter) is "0".	1. Reset counter (see customer menu).	
			2. Switching function [S18] is set to "1" without specified water quantity	2. Enter the desired water quantity (liter).	
<b>CLOSE Hood</b>			<b>Cause</b>	<b>Remedy</b>	
(running indication)			Fill cycle interrupted as hood is open.	Close hood, filling will continue.	



## 12.2 CRITICAL FAULTS

Only the drain program can be started. Fill program and all wash programs are locked.

INDICATOR			The ON/OFF button illuminates RED.		
Rinse	Wash	lamp	FAULT		PROGRAM.
F01	-- 1 -- 2		Temperature probe	Booster heating RL10 will be switched off immediately. Fill and wash programs are locked, drain program can be started.	
			<b>BOOSTER B1</b>		
			<b>Possible cause</b>	<b>Remedy</b>	
			1. -- 1 = short circuit (temperature probe or wires to probe).	1. Check wires, replace temperature probe.	
			2. -- 2 = open circuit.	2. Replace wiring, replace temperature probe if necessary.	
			3. Inlet temperature to low.	3. Check inlet temperature.	
F02	-- 1 -- 2		Temperature probe	Tank heating RL2 will be switched off immediately. Fill and wash programs are locked, drain program can be started.	
			<b>Tank B2</b>		
			<b>Possible cause</b>	<b>Remedy</b>	
			1. -- 1 = short circuit (temperature probe or wires to probe).	1. Check wires, replace temperature probe.	
			2. -- 2 = open circuit	2. Replace wiring, replace temperature probe if necessary.	
F03	-- 1 -- 2		Pressure transmitter	Control of input voltage X14.7 – min. 0.3V up to max. 4.0V. If the input voltage is out of range, the running program will be stopped. Fill and wash programs are locked, drain program can be started.	
			<b>BOOSTER B3</b>		
			<b>Possible cause</b>	<b>Remedy</b>	
			1. -- 1 = short circuit (transmitter or wires to transmitter) / > 4.0V.	1. Check wires, replace transmitter B3.	
			2. -- 2 = open circuit / < 0.3V.	2. Replace wiring, replace B3 if necessary	
F04	-- 1 -- 2		Pressure transmitter	Control of input voltage X14.10 – min. 0.3V up to max. 4.0V. If the input voltage is out of range, the running program will be stopped. Fill and wash programs are locked, drain program can be started.	
			<b>Tank B4</b>		
			<b>Possible cause</b>	<b>Remedy</b>	
			1. -- 1 = short circuit (transmitter or wires to transmitter) / > 4.0V.	1. Check wires, replace transmitter B4.	
			2. -- 2 = open circuit / < 0.3V.	2. Replace wiring, replace B4 if necessary.	
	-- 3		Pressure transmitter	The max. water quantity [C82] is exceeded and value [F16] is not reached. Only "draining" possible.	C82 F16
			<b>Tank B4 Softener</b>		
			<b>Possible cause</b>	<b>Remedy</b>	
			1. Air trap blocked or leaky.	1. Check air trap, clean or replace if necessary.	
			2. Hose to pressure transmitter leaky.	2. Replace hose.	
			3. Valve Y 4.2 locked (drain direction) or coil defective.	3. Run Softener Test. Replace switching valve if necessary.	
			4. Extension board not correctly plugged to Main PCB.	4. Plug in correctly.	
			<b>To quit the fault:</b> start drain program or reload machine program No. (U01 see page 23).		
SIE			<b>STRAINER</b>	Reed-switch [S4] (X13.7) more than 5 seconds "off".	S38
				<b>CONTROL</b>	
			<b>Possible cause</b>	<b>Remedy</b>	
			1. Tank strainer is missing or not correctly positioned.	1. Put strainer correctly in place.	
			2. Magnet at the strainer is missing.	2. Fit magnet.	
			3. Reed switch in wrong position.	3. Put reed switch in correct position.	
			4. Cable break.	4. Replace reed switch and cable.	

INDICATOR			The ON/OFF button illuminates RED.		
Rinse	Wash	Lamp	FAULT		PROGRAM
FIL			<b>FILL 1</b>	The fill valve <b>Y1 (RL7)</b> is triggered and the impeller switch <b>S2</b> does not count (no impulses on <b>X14.3</b> ). Reset via input pulses on <b>X14.3</b> or machine "OF".	
			<p><b>Possible cause with incoming water</b></p> <ol style="list-style-type: none"> <li>Bad contacts at impeller switch plug (airgap) or PCB.</li> <li>Impeller switch PCB not correctly locked.</li> <li>Reed switch in wrong position.</li> </ol> <p><b>Possible cause without incoming water</b></p> <ol style="list-style-type: none"> <li>Shut-off valve is closed.</li> <li>Fill valve Y 1 defective (wiring and pin).</li> <li>No output signal from PCB A 1 (X7.1/3).</li> </ol>	<p><b>Remedy</b></p> <ol style="list-style-type: none"> <li>Check contacts, solder plug (airgap) if necessary.</li> <li>Check PCB and lock in place.</li> <li>Put reed switch in correct position.</li> </ol> <p><b>Remedy</b></p> <ol style="list-style-type: none"> <li>Open shut-off valve at site.</li> <li>Check fill valve via service mode and replace if necessary.</li> <li>Replace PCB.</li> </ol>	
FIL			<b>FILL 2</b>	Exceeded fill time [ <b>C43</b> ]. The fill valve <b>Y1 (RL7)</b> and all other outputs will be switched off immediately. Reset via machine "OF".	
			<p><b>Possible cause</b></p> <ol style="list-style-type: none"> <li>See above.</li> <li>Line flow pressure very low.</li> <li>Line strainer clogged.</li> </ol>	<p><b>Remedy</b></p> <ol style="list-style-type: none"> <li>See above.</li> <li>Check line flow pressure.</li> <li>Clean line strainer.</li> </ol>	
FIL			<b>FILL 3</b>	External fill valve is triggered, tank level does not rise.	
			<p><b>Possible cause</b></p> <ol style="list-style-type: none"> <li>Shut-off valve is closed.</li> <li>Fill valve Y 1 defective (wiring and pin).</li> <li>Line strainer clogged.</li> </ol>	<p><b>Remedy</b></p> <ol style="list-style-type: none"> <li>Open shut-off valve at site.</li> <li>Check fill valve via service mode and replace if necessary.</li> <li>Clean line strainer.</li> </ol>	
UL			<b>OVERFLOW PROTECTION</b>	Requirement: machine "off" or "on" / hood "open" or "closed" <b>S1</b> . When [ <b>F18</b> ] is exceeded, a running program will be stopped: - after 5 seconds [ <b>S37</b> ] = "1" - immediately [ <b>S37</b> ] = "0". The drain pump <b>RL8</b> will be switched on until [ <b>F17</b> ] is below preset value.	
			<p><b>Possible cause</b></p> <ol style="list-style-type: none"> <li>Fill valve is jammed and water is running permanently.</li> <li>Hose from air trap to pressure transmitter tank (B4) is leaky.</li> <li>Not enough water is pumped out.                             <ul style="list-style-type: none"> <li>Drain pump clogged.</li> <li>Kinked drain hose.</li> </ul> </li> </ol>	<p><b>Remedy</b></p> <ol style="list-style-type: none"> <li>Replace fill valve Y1</li> <li>Drain tank manually and replace hose.</li> <li>Drain tank manually.                             <ul style="list-style-type: none"> <li>Dismantle and clean drain pump or replace if necessary.</li> <li>Place drain hose correctly.</li> </ul> </li> </ol>	
ERR			<b>INTERFACE</b>	Communication problem.	
			<p><b>Possible cause</b></p> <ol style="list-style-type: none"> <li>Broken connection: Display / Main PCB</li> <li>Defective Circuit Board.</li> </ol>	<p><b>Remedy</b></p> <ol style="list-style-type: none"> <li>Check plugs/cable and connect correctly.</li> <li>Replace PCB.</li> </ol>	

12.3 OTHER INDICATIONS

INDICATOR			The ON/OFF button is flashing blue/RED alternately.		
Rinse	Wash	Lamp	FAULT		PROGRAM
			<b>Negative Pressure</b>		
			<p><b>Possible cause</b></p> <ol style="list-style-type: none"> <li>Wash tank filters blocked.</li> </ol>	<p><b>Remedy</b></p> <ol style="list-style-type: none"> <li>Remove and flush strainers.</li> </ol>	

**NOTES**

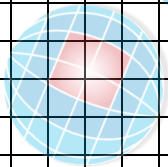

PLATON SERVICE  
8 (800) 500-34-47  
www.platonservice.com

